

Cast-in anchor channels and mounting technology

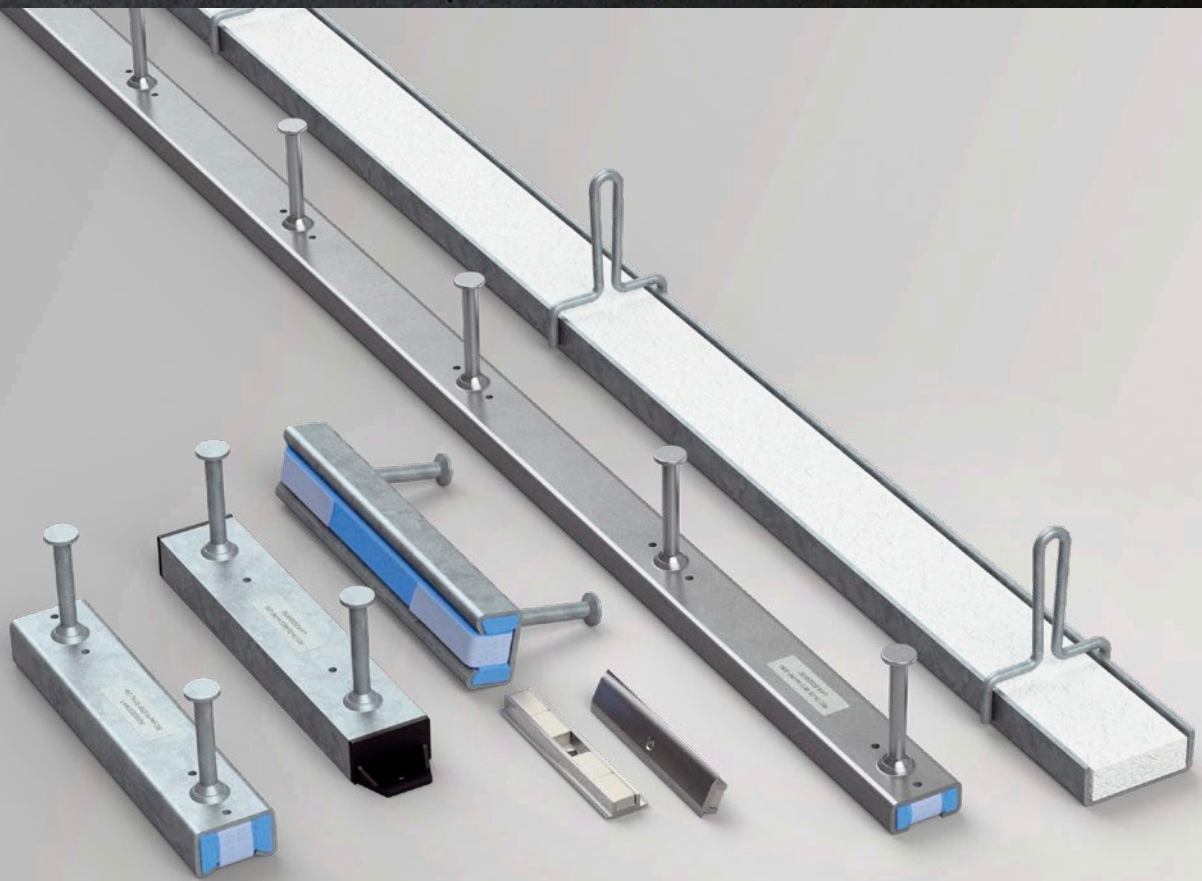

VB3-B-002-en - 04/24 - PDF

Product overview

Our products from the division BUILDING SOLUTIONS

SERVICES

- » On-site tests -> we ensure that your requirements are properly covered by our planning.
- » Test reports -> for your safety and documentation.
- » Trainings -> the knowledge of your employees from planning and production is enhanced by our experts on site, online or via webinar.
- » Planning support -> latest design software, planning documents, CAD data and much more can be downloaded any time from www.philipp-group.de.

HIGH DEMANDS ON PRODUCT SAFETY AND PRACTICALITY

- » Close cooperation with notified bodies and - if necessary - approval of our solutions.

TECHNICAL DEPARTMENT

- » Our expert-team will support you at any time during your planning phase with detailed advice.

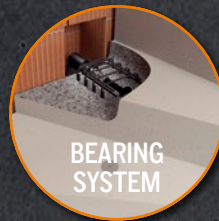
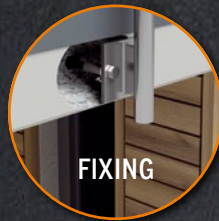
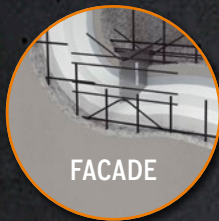
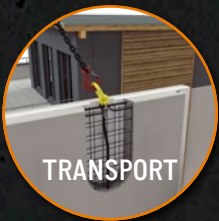

CONTENT

CAST-IN ANCHOR CHANNEL	Page	4
Overview	Page	4
Cast-in anchor channel cold-formed with studs	Page	6
Cast-in anchor channel for precast beams	Page	10
Cast-in anchor channel hot-rolled with studs	Page	11
Cast-in anchor channel (P) hot-rolled with studs	Page	14
Magnetic fastener for anchor channels	Page	14
HAMMER-HEAD T-BOLT	Page	16
HOOK-HEAD T-BOLT	Page	17
TRAPEZOIDAL ANCHOR CHANNEL	Page	18
CABLE HOLDER CHANNEL	Page	18
TOOTHED STRAP	Page	20
BRICK TIE ANCHOR	Page	20
BRICK TIE CHANNEL	Page	21
MOUNTING CHANNEL	Page	22
CLAMPING PLATE	Page	22

PHILIPP Cast-in anchor channels and mounting technology

CAST-IN ANCHOR CHANNELS COLD-FORMED WITH STUDS



MATERIAL AND VERSION

- » hot-dip galvanized
- » stainless steel A4 / SS316
- » with elastic foam
- » with integrated trigger line

Type
28 / 15

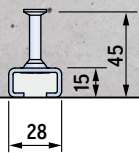

Type
38 / 17

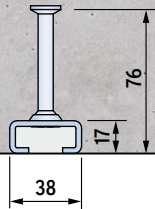

Type
40 / 25

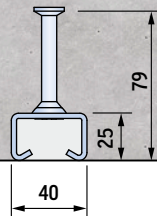

Type
49 / 30

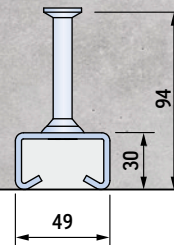

Type
54 / 33

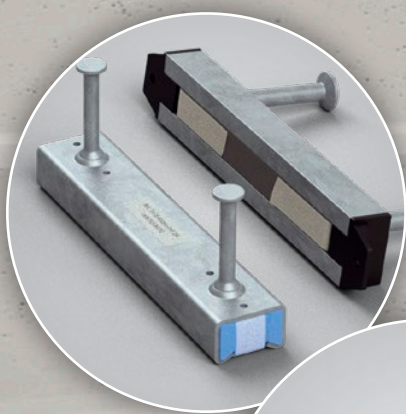
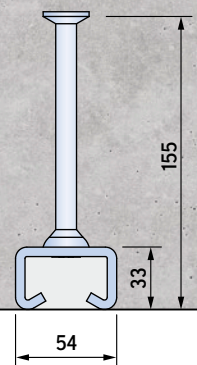

CAST-IN ANCHOR CHANNEL HOT-ROLLED WITH STUDS



MATERIAL AND VERSION

- » hot-dip galvanized
- » stainless steel A4 / SS316
- » with elastic foam
- » with locking cap on both sides
- » with integrated trigger line

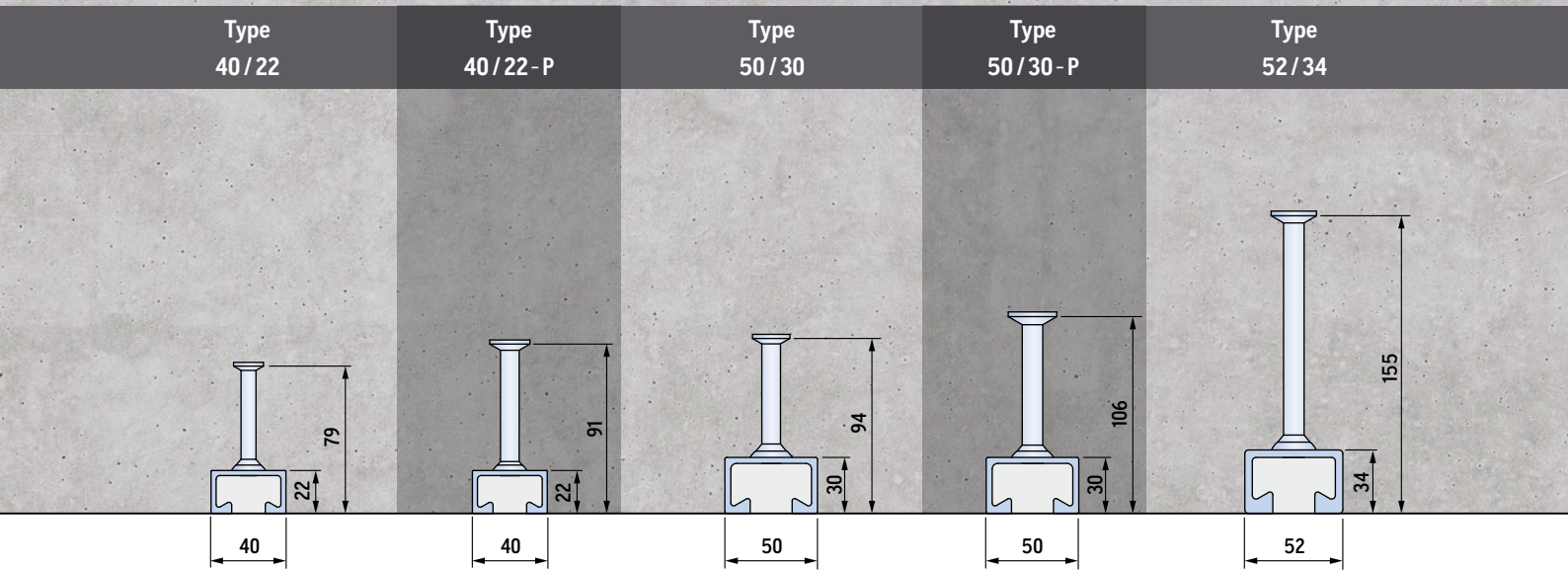

PHILIPP Cast-in anchor channels and mounting technology

CAST-IN ANCHOR CHANNEL COLD-FORMED WITH STUDS

VERSION: COLD-FORMED, HOT-DIP GALVANIZED			
Type	Length (mm)	Number of anchors (pcs.)	Ref. no.
28/15	100	2	8228150100FV
28/15	150	2	8228150150FV
28/15	200	2	8228150200FV
28/15	250	2	8228150250FV
28/15	300	2	8228150300FV
28/15	350	3	8228150350FV
28/15	450	3	8228150450FV
28/15	550	4	8228150550FV
28/15	850	5	8228150850FV
28/15	1,050	6	8228151050FV
28/15	3,050	16	8228153050FV
28/15	6,070	31	8228156070FV

- With elastic foam and integrated trigger line.
- Special lengths available on request.

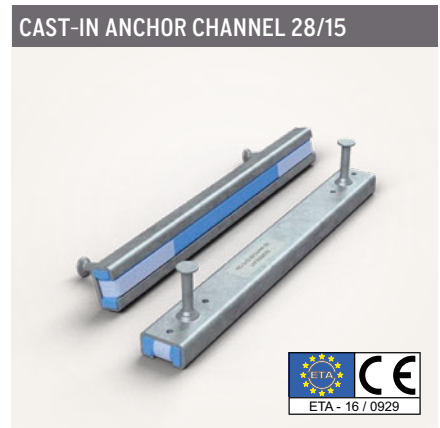

VERSION: COLD-FORMED, STAINLESS STEEL A4 / SS316			
Type	Length (mm)	Number of anchors (pcs.)	Ref. no.
28/15	100	2	8228150100VA
28/15	150	2	8228150150VA
28/15	200	2	8228150200VA
28/15	250	2	8228150250VA
28/15	300	2	8228150300VA
28/15	350	3	8228150350VA
28/15	450	3	8228150450VA
28/15	550	4	8228150550VA
28/15	850	5	8228150850VA
28/15	1,050	6	8228151050VA
28/15	3,050	16	8228153050VA
28/15	6,070	31	8228156070VA

- With elastic foam and integrated trigger line.
- Special lengths available on request.



CAST-IN ANCHOR CHANNEL COLD-FORMED WITH STUDS

VERSION: COLD-FORMED, HOT-DIP GALVANIZED			
Type	Length (mm)	Number of anchors (pcs.)	Ref. no.
38/17	100 ①	2	8228150100FV
38/17	150	2	8228150150FV
38/17	200	2	8228150200FV
38/17	250	2	8228150250FV
38/17	300	3	8228150300FV
38/17	350	3	8228150350FV
38/17	450	3	8228150450FV
38/17	550	4	8228150550FV
38/17	850	5	8228150850FV
38/17	1,050	6	8228151050FV
38/17	3,050	16	8228153050FV
38/17	6,070	31	8228156070FV

① Length not covered by ETA.

- With elastic foam and integrated trigger line.
- Special lengths available on request.

VERSION: COLD-FORMED, STAINLESS STEEL A4 / SS316			
Type	Length (mm)	Number of anchors (pcs.)	Ref. no.
38/17	100 ①	2	8238170100VA
38/17	150	2	8238170150VA
38/17	200	2	8238170200VA
38/17	250	2	8238170250VA
38/17	300	3	8238170300VA
38/17	350	3	8238170350VA
38/17	450	3	8238170450VA
38/17	550	4	8238170550VA
38/17	850	5	8238170850VA
38/17	1,050	6	8238171050VA
38/17	3,050	16	8238173050VA
38/17	6,070	31	8238176070VA

① Length not covered by ETA.

- With elastic foam and integrated trigger line.
- Special lengths available on request.

CAST-IN ANCHOR CHANNEL 38/17

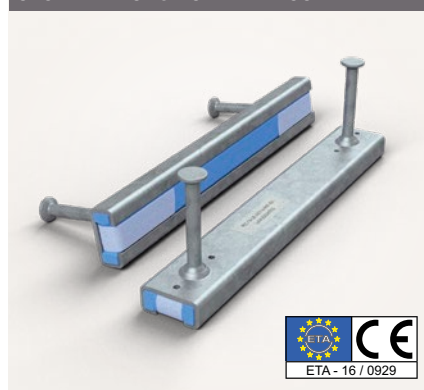

CAST-IN ANCHOR CHANNEL 38/17

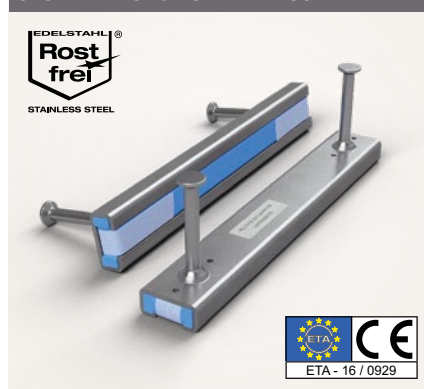

PHILIPP Cast-in anchor channels and mounting technology

CAST-IN ANCHOR CHANNEL COLD-FORMED WITH STUDS

VERSION: COLD-FORMED, HOT-DIP GALVANIZED			
Type	Length (mm)	Number of anchors (pcs.)	Ref. no.
40/25	150	2	8240250150FV
40/25	200	2	8240250200FV
40/25	250	2	8240250250FV
40/25	300	2	8240250300FV
40/25	350	3	8240250350FV
40/25	400	3	8240250400FV
40/25	550	3	8240250550FV
40/25	800	4	8240250800FV
40/25	1,050	5	8240251050FV
40/25	3,050	13	8240253050FV
40/25	6,070	25	8240256070FV

- With elastic foam and integrated trigger line.
- Special lengths available on request.



VERSION: COLD-FORMED, STAINLESS STEEL A4 / SS316			
Type	Length (mm)	Number of anchors (pcs.)	Ref. no.
40/25	150	2	8240250150VA
40/25	200	2	8240250200VA
40/25	250	2	8240250250VA
40/25	300	2	8240250300VA
40/25	350	3	8240250350VA
40/25	400	3	8240250400VA
40/25	550	3	8240250550VA
40/25	800	4	8240250800VA
40/25	1,050	5	8240251050VA
40/25	3,050	13	8240253050VA
40/25	6,070	25	8240256070VA

- With elastic foam and integrated trigger line.
- Special lengths available on request.

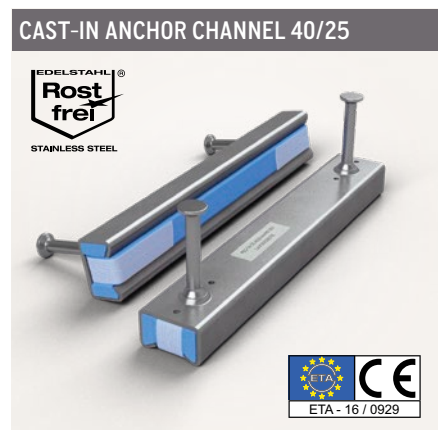

CAST-IN ANCHOR CHANNEL COLD-FORMED WITH STUDS

VERSION: COLD-FORMED, HOT-DIP GALVANIZED

Type	Length (mm)	Number of anchors (pcs.)	Ref. no.
49/30	150	2	8249300150FV
49/30	200	2	8249300200FV
49/30	250	2	8249300250FV
49/30	300	2	8249300300FV
49/30	350	3	8249300350FV
49/30	400	3	8249300400FV
49/30	550	3	8249300550FV
49/30	800	4	8249300800FV
49/30	1,050	5	8249301050FV
49/30	3,050	13	8249303050FV
49/30	6,070	25	8249306070FV

- With elastic foam and integrated trigger line.
- Special lengths available on request.

CAST-IN ANCHOR CHANNEL 49/30

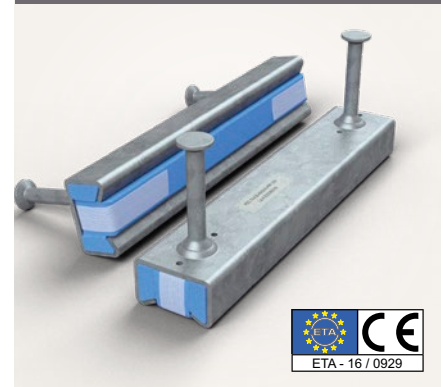

VERSION: COLD-FORMED, STAINLESS STEEL A4 / SS316

Type	Length (mm)	Number of anchors (pcs.)	Ref. no.
49/30	150	2	8249300150VA
49/30	200	2	8249300200VA
49/30	250	2	8249300250VA
49/30	300	2	8249300300VA
49/30	350	3	8249300350VA
49/30	400	3	8249300400VA
49/30	550	3	8249300550VA
49/30	800	4	8249300800VA
49/30	1,050	5	8249301050VA
49/30	3,050	13	8249303050VA
49/30	6,070	25	8249306070VA

- With elastic foam and integrated trigger line.
- Special lengths available on request.

CAST-IN ANCHOR CHANNEL 49/30

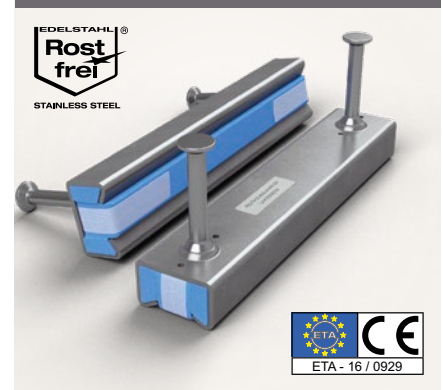

PHILIPP Cast-in anchor channels and mounting technology

CAST-IN ANCHOR CHANNEL COLD-FORMED WITH STUDS

VERSION: COLD-FORMED, HOT-DIP GALVANIZED			
Type	Length (mm)	Number of anchors (pcs.)	Ref. no.
54/33	150	2	8254330150FV
54/33	200	2	8254330200FV
54/33	250	2	8254330250FV
54/33	300	2	8254330300FV
54/33	350	3	8254330350FV
54/33	400	3	8254330400FV
54/33	550	3	8254330550FV
54/33	800	4	8254330800FV
54/33	1,050	5	8254331050FV
54/33	3,050	13	8254333050FV
54/33	6,070	25	8254336070FV

- With elastic foam and integrated trigger line.
- Special lengths available on request.



VERSION: COLD-FORMED, STAINLESS STEEL A4 / SS316			
Type	Length (mm)	Number of anchors (pcs.)	Ref. no.
40/25	150	2	8240250150VA
40/25	200	2	8240250200VA
40/25	250	2	8240250250VA
40/25	300	2	8240250300VA
40/25	350	3	8240250350VA
40/25	400	3	8240250400VA
40/25	550	3	8240250550VA
40/25	800	4	8240250800VA
40/25	1,050	5	8240251050VA
40/25	3,050	13	8240253050VA
40/25	6,070	25	8240256070VA

- With elastic foam and integrated trigger line.
- Special lengths available on request.



CAST-IN ANCHOR CHANNEL FOR PRECAST CONCRETE LINTELS, STAINLESS STEEL A4 / SS316			
Type	Length (mm)	Load class (kN)	Ref. no.
28/15	150	3.5	82ES2815VA
38/17	150	7.0	82ES3817VA

- With elastic foam and integrated trigger line.
- Special lengths available on request.

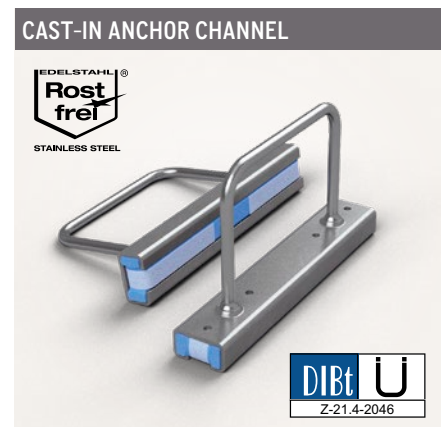

CAST-IN ANCHOR CHANNEL HOT-ROLLED WITH STUDS

VERSION: HOT-ROLLED, HOT-DIP GALVANIZED			
Type	Length (mm)	Number of anchors (pcs.)	Ref. no.
40/22	150	2	8240220150FV
40/22	200	2	8240220200FV
40/22	250	2	8240220250FV
40/22	300	2	8240220300FV
40/22	350	3	8240220350FV
40/22	400	3	8240220400FV
40/22	550	3	8240220550FV
40/22	800	4	8240220800FV
40/22	1,050	5	8240221050FV
40/22	1,300	6	8240221300FV
40/22	1,550	7	8240221550FV
40/22	1,800	8	8240221800FV
40/22	2,050	9	8240222050FV
40/22	2,300	10	8240222300FV
40/22	3,050	13	8240223050FV
40/22	6,070	25	8240226070FV

- With elastic foam, both-sided locking cap and integrated trigger line.
- Special lengths available on request.

VERSION: HOT-ROLLED, STAINLESS STEEL A4 / SS316			
Type	Length (mm)	Number of anchors (pcs.)	Ref. no.
40/22	150	2	8240220150VA
40/22	200	2	8240220200VA
40/22	250	2	8240220250VA
40/22	300	2	8240220300VA
40/22	350	3	8240220350VA
40/22	400	3	8240220400VA
40/22	550	3	8240220550VA
40/22	800	4	8240220800VA
40/22	1,050	5	8240221050VA
40/22	3,050	13	8240223050VA
40/22	6,070	25	8240226070VA

- With elastic foam, both-sided locking cap and integrated trigger line.
- Special lengths available on request.



PHILIPP Cast-in anchor channels and mounting technology

CAST-IN ANCHOR CHANNEL HOT-ROLLED WITH STUDS

VERSION: HOT-ROLLED, HOT-DIP GALVANIZED			
Type	Length (mm)	Number of anchors (pcs.)	Ref. no.
50/30	150	2	8250300150FV
50/30	200	2	8250300200FV
50/30	250	2	8250300250FV
50/30	300	2	8250300300FV
50/30	350	3	8250300350FV
50/30	400	3	8250300400FV
50/30	550	3	8250300550FV
50/30	800	4	8250300800FV
50/30	1,050	5	8250301050FV
50/30	3,050	13	8250303050FV
50/30	6,070	25	8250306070FV

- With elastic foam, both-sided locking cap and integrated trigger line.
- Special lengths available on request.



VERSION: HOT-ROLLED, STAINLESS STEEL A4 / SS316			
Type	Length (mm)	Number of anchors (pcs.)	Ref. no.
50/30	150	2	8250300150VA
50/30	200	2	8250300200VA
50/30	250	2	8250300250VA
50/30	300	2	8250300300VA
50/30	350	3	8250300350VA
50/30	400	3	8250300400VA
50/30	550	3	8250300550VA
50/30	800	4	8250300800VA
50/30	1,050	5	8250301050VA
50/30	3,050	13	8250303050VA
50/30	6,070	25	8250306070VA

- With elastic foam, both-sided locking cap and integrated trigger line.
- Special lengths available on request.



CAST-IN ANCHOR CHANNEL HOT-ROLLED WITH STUDS

VERSION: HOT-ROLLED, HOT-DIP GALVANIZED			
Type	Length (mm)	Number of anchors (pcs.)	Ref. no.
52/34	170	2	8252340170FV
52/34	200	2	8252340200FV
52/34	250	2	8252340250FV
52/34	300	2	8252340300FV
52/34	350	3	8252340350FV
52/34	400	3	8252340400FV
52/34	550	3	8252340550FV
52/34	800	4	8252340800FV
52/34	1,050	5	8252341050FV
52/34	3,050	13	8252343050FV
52/34	6,070	25	8252346070FV

- With elastic foam, both-sided locking cap and integrated trigger line.
- Special lengths available on request.



VERSION: HOT-ROLLED, STAINLESS STEEL A4 / SS316			
Type	Length (mm)	Number of anchors (pcs.)	Ref. no.
52/34	170	2	8252340170VA
52/34	200	2	8252340200VA
52/34	250	2	8252340250VA
52/34	300	2	8252340300VA
52/34	350	3	8252340350VA
52/34	400	3	8252340400VA
52/34	550	3	8252340550VA
52/34	800	4	8252340800VA
52/34	1,050	5	8252341050VA
52/34	3,050	13	8252343050VA
52/34	6,070	25	8252346070VA

- With elastic foam, both-sided locking cap and integrated trigger line.
- Special lengths available on request.



PHILIPP Cast-in anchor channels and mounting technology

CAST-IN ANCHOR CHANNEL HOT-ROLLED WITH STUDS

VERSION: HOT-ROLLED, HOT-DIP GALVANIZED			
Type	Length (mm)	Number of anchors (pcs.)	Ref. no.
40/22-P	150	2	824022P0150FV
40/22-P	200	2	824022P0200FV
40/22-P	250	2	824022P0250FV
40/22-P	300	2	824022P0300FV
40/22-P	350	3	824022P0350FV
40/22-P	400	3	824022P0400FV
40/22-P	550	3	824022P0550FV
40/22-P	800	4	824022P0800FV
40/22-P	1,050	5	824022P1050FV
40/22-P	1,300	6	824022P1300FV
40/22-P	1,550	7	824022P1550FV
40/22-P	1,800	8	824022P1800FV
40/22-P	2,050	9	824022P2050FV
40/22-P	2,300	10	824022P2300FV
40/22-P	3,050	13	824022P3050FV
40/22-P	6,070	25	824022P6070FV

- With elastic foam, both-sided locking cap and integrated trigger line.
- Special lengths available on request.



VERSION: HOT-ROLLED, STAINLESS STEEL A4 / SS316			
Type	Length (mm)	Number of anchors (pcs.)	Ref. no.
40/22-P	150	2	824022P0150VA
40/22-P	200	2	824022P0200VA
40/22-P	250	2	824022P0250VA
40/22-P	300	2	824022P0300VA
40/22-P	350	3	824022P0350VA
40/22-P	400	3	824022P0400VA
40/22-P	550	3	824022P0550VA
40/22-P	800	4	824022P0800VA
40/22-P	1,050	5	824022P1050VA
40/22-P	3,050	13	824022P3050VA
40/22-P	6,070	25	824022P6070VA

- With elastic foam, both-sided locking cap and integrated trigger line.
- Special lengths available on request.



CAST-IN ANCHOR CHANNEL HOT-ROLLED WITH STUDS

VERSION: 50/30-P HOT-ROLLED, HOT-DIP GALVANIZED			
Type	Length (mm)	Number of anchors (pcs.)	Ref. no.
50/30-P	150	2	825030P0150FV
50/30-P	200	2	825030P0200FV
50/30-P	250	2	825030P0250FV
50/30-P	300	2	825030P0300FV
50/30-P	350	3	825030P0350FV
50/30-P	400	3	825030P0400FV
50/30-P	550	3	825030P0550FV
50/30-P	800	4	825030P0800FV
50/30-P	1,050	5	825030P1050FV
50/30-P	3,050	13	825030P3050FV
50/30-P	6,070	25	825030P6070FV

- With elastic foam, both-sided locking cap and integrated trigger line.
- Special lengths available on request.



VERSION: 50/30-P HOT-ROLLED, STAINLESS STEEL A4 / SS316			
Type	Length (mm)	Number of anchors (pcs.)	Ref. no.
50/30-P	150	2	825030P0150VA
50/30-P	200	2	825030P0200VA
50/30-P	250	2	825030P0250VA
50/30-P	300	2	825030P0300VA
50/30-P	350	3	825030P0350VA
50/30-P	400	3	825030P0400VA
50/30-P	550	3	825030P0550VA
50/30-P	800	4	825030P0800VA
50/30-P	1,050	5	825030P1050VA
50/30-P	3,050	13	825030P3050VA
50/30-P	6,070	25	825030P6070VA

- With elastic foam, both-sided locking cap and integrated trigger line.
- Special lengths available on request.



MAGNETIC FASTENER FOR ANCHOR CHANNELS												
Type	Adhesive force (kg)	Suitable for cast-in anchor channels (hot-dip galvanized / stainless steel)										Ref. no.
		28/15	38/17	40/25	49/30	54/33	40/22	40/22-P	50/30	50/30-P	52/34	
28/15	26	●	-	-	-	-	-	-	-	-	-	82MAX2815
38/17	30	-	●	-	-	-	-	-	-	-	-	82MAX3817
40/22	30	-	-	-	-	-	●	●	-	-	-	82MAX4022
40/25	30	-	-	●	-	-	-	-	-	-	-	82MAX4025
50/30	30	-	-	-	●	●	-	-	●	●	-	82MAX5030
52/34	30	-	-	-	-	-	-	-	-	-	●	82MAX5234



HAMMER HEAD BOLT

HAMMER HEAD BOLT HKS-28/15 (INCL. NUT)				
Length (mm)	Ref. no. 82HKS2815...			
	M6	M8	M10	M12
Hot-dip galvanized 8.8				
30	...06030FV	...08030FV	...10030FV	...12030FV
40	...06040FV	...08040FV	...10040FV	...12040FV
50	...06050FV	...08050FV	...10050FV	...12050FV
60	...06060FV	...08060FV	...10060FV	...12060FV
70	...06070FV	...08070FV	...10070FV	...12070FV
80	...06080FV	...08080FV	...10080FV	...12080FV
90	...06090FV	...08090FV	...10090FV	...12090FV
100	...06100FV	...08100FV	...10100FV	...12100FV
Stainless steel A4-70 / SS316				
30	...06030VA	...08030VA	...10030VA	...12030VA
40	...06040VA	...08040VA	...10040VA	...12040VA
50	...06050VA	...08050VA	...10050VA	...12050VA
60	...06060VA	...08060VA	...10060VA	...12060VA
70	...06070VA	...08070VA	...10070VA	...12070VA
80	...06080VA	...08080VA	...10080VA	...12080VA
90	...06090VA	...08090VA	...10090VA	...12090VA
100	...06100VA	...08100VA	...10100VA	...12100VA

HAMMER HEAD BOLT



Suitable for following profiles:
- 28/15

HAMMER HEAD BOLT HKS-38/17 (INCL. NUT)				
Length (mm)	Ref. no. 82HKS3817...			
	M8	M10	M12	M16
Hot-dip galvanized 8.8				
30	...08030FV	...10030FV	...12030FV	...16030FV
40	...08040FV	...10040FV	...12040FV	...16040FV
50	...08050FV	...10050FV	...12050FV	...16050FV
60	...08060FV	...10060FV	...12060FV	...16060FV
70	...08070FV	...10070FV	...12070FV	...16070FV
80	...08080FV	...10080FV	...12080FV	...16080FV
90	...08090FV	...10090FV	...12090FV	...16090FV
100	...08100FV	...10100FV	...12100FV	...16100FV
Stainless steel A4-70 / SS316				
30	...08030VA	...10030VA	...12030VA	...16030VA
40	...08040VA	...10040VA	...12040VA	...16040VA
50	...08050VA	...10050VA	...12050VA	...16050VA
60	...08060VA	...10060VA	...12060VA	...16060VA
70	...08070VA	...10070VA	...12070VA	...16070VA
80	...08080VA	...10080VA	...12080VA	...16080VA
90	...08090VA	...10090VA	...12090VA	...16090VA
100	...08100VA	...10100VA	...12100VA	...16100VA

HAMMER HEAD BOLT



Suitable for following profiles:
- 38/17

HOOK HEAD BOLT

HOOK HEAD BOLT HKS-40/22 (INCL. NUT)			
Length (mm)	Ref. no. 82HKS4022...		
	M10	M12	M16
Hot-dip galvanized 8.8			
30	...10030FV	...12030FV	...16030FV
40	...10040FV	...12040FV	...16040FV
50	...10050FV	...12050FV	...16050FV
60	...10060FV	...12060FV	...16060FV
70	...10070FV	...12070FV	...16070FV
80	...10080FV	...12080FV	...16080FV
90	...10090FV	...12090FV	...16090FV
100	...10100FV	...12100FV	...16100FV
Stainless steel A4-70 / SS316			
30	...10030VA	...12030VA	...16030VA
40	...10040VA	...12040VA	...16040VA
50	...10050VA	...12050VA	...16050VA
60	...10060VA	...12060VA	...16060VA
70	...10070VA	...12070VA	...16070VA
80	...10080VA	...12080VA	...16080VA
90	...10090VA	...12090VA	...16090VA
100	...10100VA	...12100VA	...16100VA



Suitable for following profiles:
- 40/22
- 40/25

HOOK HEAD BOLT HKS-50/30 (INCL. NUT)				
Length (mm)	Ref. no. 82HKS5030...			
	M10	M12	M16	M20
Hot-dip galvanized 8.8				
30	...10030FV	...12030FV	...16030FV	...20030FV
40	...10040FV	...12040FV	...16040FV	...20040FV
50	...10050FV	...12050FV	...16050FV	...20050FV
60	...10060FV	...12060FV	...16060FV	...20060FV
70	...10070FV	...12070FV	...16070FV	...20070FV
80	...10080FV	...12080FV	...16080FV	...20080FV
90	...10090FV	...12090FV	...16090FV	...20090FV
100	...10100FV	...12100FV	...16100FV	...20100FV
Stainless steel A4-70 / SS316				
30	...10030VA	...12030VA	...16030VA	...20030VA
40	...10040VA	...12040VA	...16040VA	...20040VA
50	...10050VA	...12050VA	...16050VA	...20050VA
60	...10060VA	...12060VA	...16060VA	...20060VA
70	...10070VA	...12070VA	...16070VA	...20070VA
80	...10080VA	...12080VA	...16080VA	...20080VA
90	...10090VA	...12090VA	...16090VA	...20090VA
100	...10100VA	...12100VA	...16100VA	...20100VA



Suitable for following profiles:
- 54/33
- 52/34
- 50/30
- 49/30

PHILIPP Cast-in anchor channels and mounting technology

TRAPEZOIDAL ANCHOR CHANNEL / CABLE HOLDER CHANNEL

VERSION: HOT-DIP GALVANIZED (FV)			
Type	Length (mm)	Number of anchors (pcs.)	Ref. no.
A	3,000	8	82TS3A300008FV
A	3,000	20	82TS3A300020FV
B	3,000	8	82TS3B300008FV
B	3,000	20	82TS3B300020FV
C	3,000	8	82TS3C300008FV
C	3,000	20	82TS3C300020FV

- Version: pair of single anchor strips 3 mm, hot-dip galvanized, styrofoam filling.

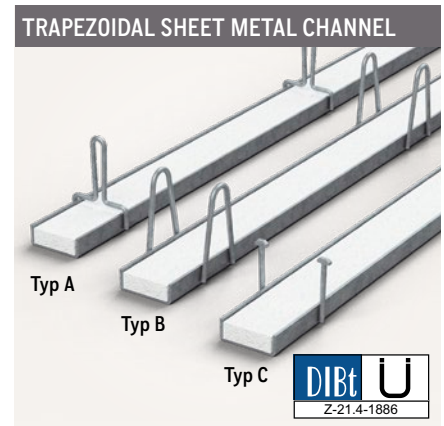

VERSION: HOT-DIP GALVANIZED			
Type	Length (mm)	Number of anchors (pcs.)	Ref. no.
70/28	670	7	82KHB0670FV
70/28	820	8	82KHB0820FV
70/28	970	9	82KHB0970FV
70/28	1,120	10	82KHB1120FV
70/28	1,270	11	82KHB1270FV
70/28	1,345	12	82KHB1345FV
70/28	1,645	14	82KHB1645FV
70/28	1,945	16	82KHB1945FV
70/28	2,245	18	82KHB2245FV
70/28	2,545	20	82KHB2545FV

- With elastic foam and integrated trigger line.
- Special lengths available on request.

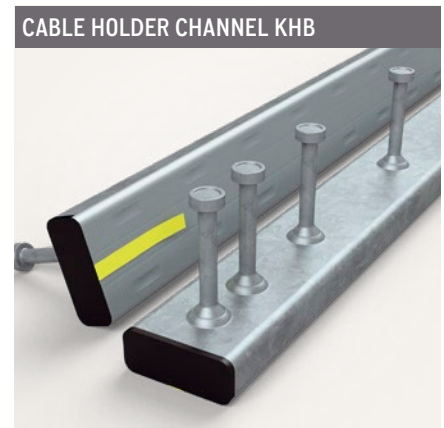

VERSION: HOT-DIP GALVANIZED			
Type	Length (mm)	Punching	Ref. no.
70/28	1,400	Ø13	82KHM1400FV
70/28	1,700	Ø13	82KHM1700FV
70/28	2,000	Ø13	82KHM2000FV
70/28	2,300	Ø13	82KHM2300FV
70/28	2,600	Ø13	82KHM2600FV

- Special lengths available on request.
- Fixing material: Hilti - HST - M12 acc. to ETA-98/0001, for use in concrete.
- Minimum concrete strength C 20/25, post-installed anchor M12 for concrete and masonry $h_{ef} \geq 90$ mm.
- Minimum 1 anchor per metre, minimum 2 anchors per channel.

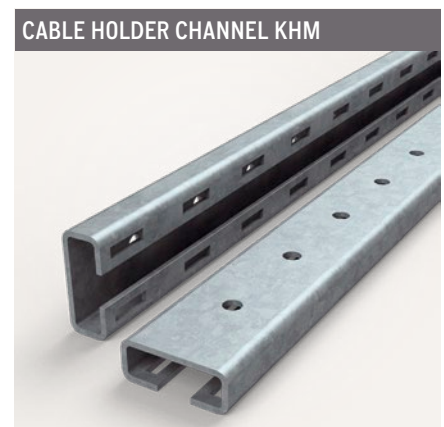

CABLE HOLDER CHANNEL

VERSION: PLASTIC	
Type	Ref. no.
70/28	82KHE7028

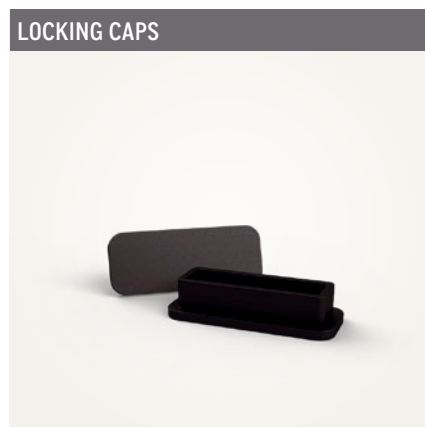

VERSION: HOT-DIP GALVANIZED / PLASTIC		
Type	Length console (mm)	Ref. no.
70/28	210	82KKH210FV
70/28	310	82KKH310FV
70/28	420	82KKH420FV
70/28	600	82KKH600FV



VERSION: HOT-DIP GALVANIZED / PLASTIC		
Type	Length console (mm)	Ref. no.
70/28	210	82KWB210FV
70/28	310	82KWB310FV
70/28	420	82KWB420FV
70/28	600	82KWB600FV



PHILIPP Cast-in anchor channels and mounting technology

TOOTHED STRAP / BRICK TIE ANCOR

VERSION: GALVANIZED (INCL. TOOTHED COUNTER PLATE)		
Type	Length (mm)	Ref. no.
Suitable for profile 28/15		
28/15	115	82VL2815075VC
28/15	140	82VL2815100VC
28/15	165	82VL2815125VC
28/15	190	82VL2815150VC
28/15	215	82VL2815175VC
28/15	240	82VL2815200VC
Suitable for profile 38/17		
38/17	115	82VL3817075VC
38/17	140	82VL3817100VC
38/17	165	82VL3817125VC
38/17	190	82VL3817150VC
38/17	215	82VL3817175VC
38/17	240	82VL3817200VC

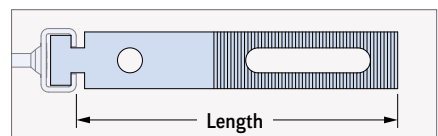

VERSION: STAINLESS STEEL (INCL. TOOTHED COUNTER PLATE)		
Type	Length (mm)	Ref. no.
Suitable for profile 28/15		
28/15	115	82VL2815075VA
28/15	140	82VL2815100VA
28/15	165	82VL2815125VA
28/15	190	82VL2815150VA
28/15	215	82VL2815175VA
28/15	240	82VL2815200VA
Suitable for profile 38/17		
38/17	115	82VL3817075VA
38/17	140	82VL3817100VA
38/17	165	82VL3817125VA
38/17	190	82VL3817150VA
38/17	215	82VL3817175VA
38/17	240	82VL3817200VA

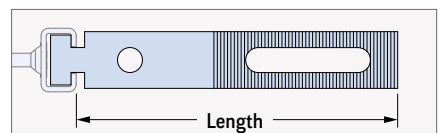

VERSION: SENDZIMIR ZINC PLATED / STAINLESS STEEL		
Type (suitable for profile)	Length (mm)	Ref. no.
Sendzimir zinc plated		
38/17	85	82BL085SV
38/17	120	82BL120SV
38/17	180	82BL180SV
Stainless steel		
38/17	120	82BL120VA
38/17	180	82BL180VA



BRICK TIE CHANNEL

VERSION: SENDZIMIR ZINC PLATED / STAINLESS STEEL			
Type	Length (mm)	Number of anchors (pcs.)	Ref. no.
Sendzimir zinc plated			
25/15	2,500	10	82MAS25152500SV
Stainless steel			
25/15	2,500	10	82MAS25152500VA

- With elastic foam.

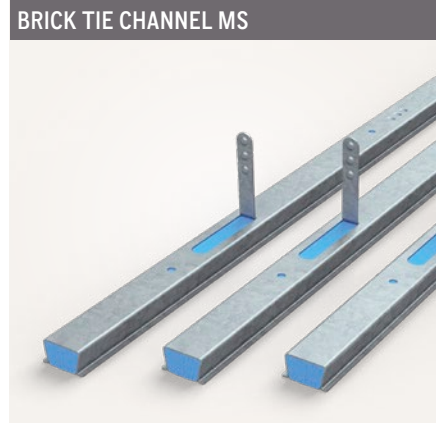

VERSION: HOT-DIP GALVANIZED / STAINLESS STEEL		
Type (suitable for profile)	Length (mm)	Ref. no.
Hot-dip galvanized		
25/15 und 28/15	85	82ML085FV
25/15 und 28/15	120	82ML120FV
25/15 und 28/15	180	82ML180FV
Stainless steel		
25/15 und 28/15	120	82ML120VA
25/15 und 28/15	180	82ML180VA



VERSION: STAINLESS STEEL		
Type (suitable for profile)	Length (mm)	Ref. no.
25/15 und 28/15	120	82PB120VA
25/15 und 28/15	150	82PB150VA
25/15 und 28/15	180	82PB180VA
25/15 und 28/15	240	82PB240VA



PHILIPP Cast-in anchor channels and mounting technology

MOUNTING CHANNEL / CLAMPING PLATE

VERSION: HOT-ROLLED					
Type	Length (mm)	Ref. no.			
		bright	hot-dip galvanized	stainless steel	
40/22	6,070	82MS402206070BL	82MS402206070FV	82MS402206070VA	
50/30	6,070	82MS503006070BL	82MS503006070FV	82MS503006070VA	
52/34	6,070	82MS523406070BL	82MS523406070FV	82MS523406070VA	

Other dimensions available on request.



VERSION: COLD-FORMED					
Type	Length (mm)	Ref. no.			
		bright	hot-dip galvanized	stainless steel	
28/15	6,070	82MS281506070BL	82MS281506070FV	82MS281506070VA	
38/17	6,070	82MS381706070BL	82MS381706070FV	82MS381706070VA	

Other dimensions available on request.



VERSION: COLD-FORMED WITH PUNCHING					
Type	Length (mm)	Ref. no.			
		hot-dip galvanized	stainless steel		
28/15	3,050	82MS281503050FVL	-		
28/15	6,070	82MS281506070FVL	82MS281506070VAL		

Other dimensions available on request.

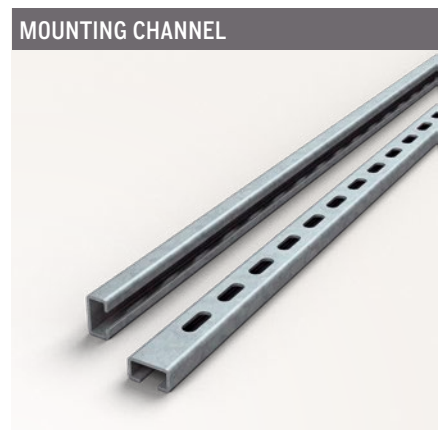

VERSION: HOT-DIP GALVANIZED					
Clamping height (mm)	Slotted hole (mm)	Length (mm)	Width (mm)	Height (mm)	Ref. no.
10	18 × 24	75	60	28	82KLP6010
12	18 × 24	75	60	30	82KLP6012
14	18 × 24	75	60	32	82KLP6014
16	18 × 24	75	60	34	82KLP6016
18	18 × 24	75	60	36	82KLP6018
20	18 × 24	75	60	38	82KLP6020



NOTES

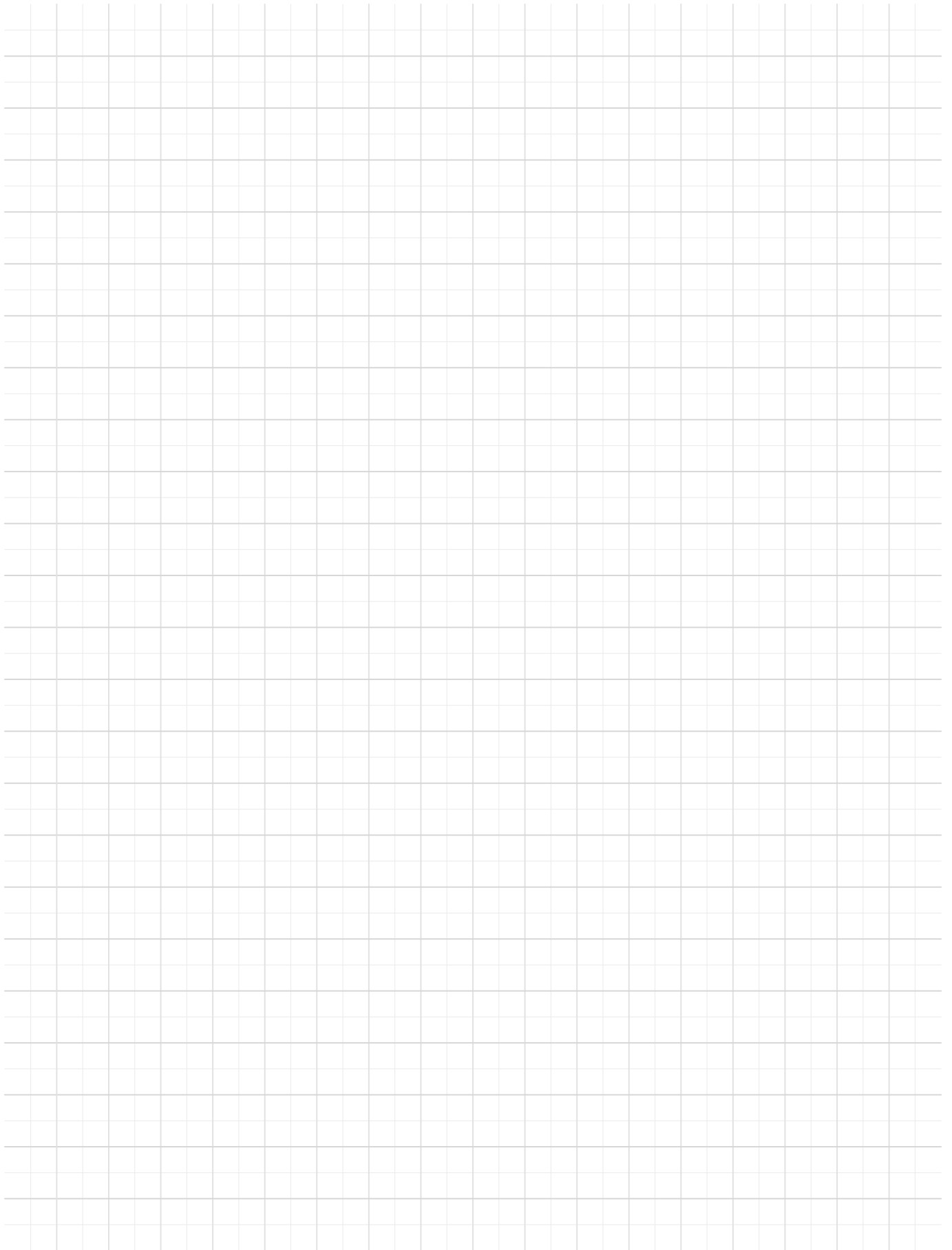



**PHILIPP GmbH
Headquarters**

Lilienthalstraße 7-9
63741 Aschaffenburg

+49 6021 40 27-0

info@philipp-gruppe.de

**PHILIPP GmbH
Production and logistics**

Hauptstraße 204
63814 Mainaschaff

+49 6021 40 27-0

info@philipp-gruppe.de

**PHILIPP GmbH
Office Coswig**

Roßlauer Straße 70
06869 Coswig/Anhalt

+49 34903 6 94-0

info@philipp-gruppe.de

**PHILIPP GmbH
Office Neuss**

Sperberweg 37
41468 Neuss

+49 2131 3 59 18-0

info@philipp-gruppe.de



PHILIPP Vertriebs GmbH

Pfaffing 36
5760 Saalfelden / Salzburg

+43 6582 7 04 01

info@philipp-gruppe.at



Visit us!

www.philipp-group.de